



# Dino's Delightful Day Book™



## Parent's Guide

This guide contains important information. Please keep it for future reference.

# INTRODUCTION

Thank you for purchasing **Dino's Delightful Day Book™**! As your child reads the story, they'll learn about letters, the sounds these letters make, and words that start with these letters. Read about Dino's day in this complete story with a beginning, middle and end to foster early reading skills.

Volume  
Control  
Switch

10

Number  
Buttons

Butterfly  
Button

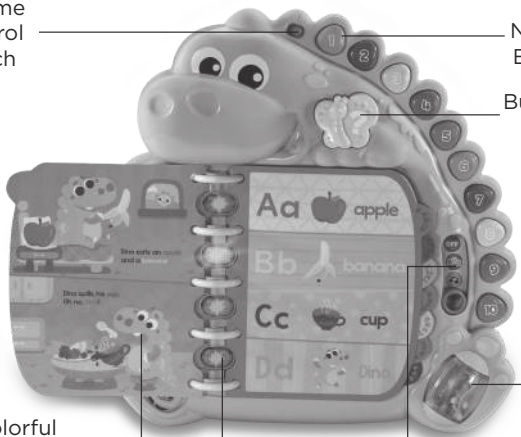

16 Colorful  
Pages

4 Light-Up  
Buttons

Bead  
Roller

Off/Mode Selector Switch

# INCLUDED IN THIS PACKAGE

- One **Dino's Delightful Day Book™**
- One parent's guide

## **WARNING:**

All packing materials, such as tape, plastic sheets, packaging locks, removable tags, cable ties and packaging screws are not part of this toy, and should be discarded for your child's safety.

## **NOTE:**

Please keep this parent's guide as it contains important information.

## **ATTENTION:**

Pour la sécurité de votre enfant, débarrassez-vous de tous les produits d'emballage tels que rubans adhésifs, feuilles de plastique, attaches, étiquettes et vis d'emballage. Ils ne font pas partie du jouet.

## **NOTE:**

Il est conseillé de conserver ce guide des parents car il comporte des informations importantes.

## **Unlock the packaging locks:**

- ① Rotate the packaging locks 90 degrees counterclockwise.
- ② Pull out the packaging locks and discard.

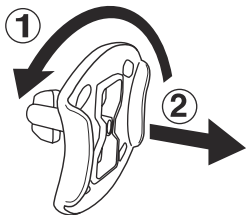

# GETTING STARTED

## BATTERY INSTALLATION

1. Make sure the unit is turned **OFF**.
2. Locate the battery cover on the bottom of the unit.
3. Use a screwdriver to loosen the screw and open the battery cover.
4. Install 2 new AA (AM-3/LR6) batteries into the battery box as illustrated. (The use of new alkaline batteries is recommended for maximum performance.)
5. Replace the battery cover and tighten the screw to secure.

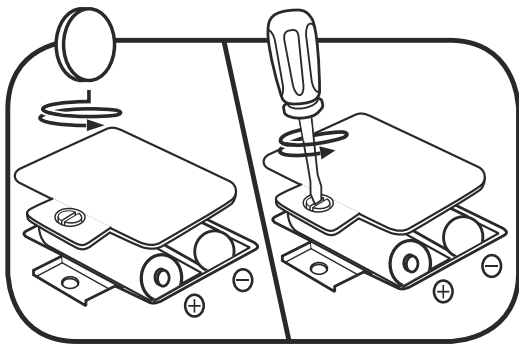

## **BATTERY NOTICE**

- Use new alkaline batteries for maximum performance.
- Use only batteries of the same or equivalent type as recommended.
- Do not mix different types of batteries: alkaline, standard (carbon-zinc) or rechargeable, or new and used batteries.
- Do not use damaged batteries.
- Insert batteries with the correct polarity.
- Do not short-circuit the battery terminals.
- Remove exhausted batteries from the toy.
- Remove batteries during long periods of non-use.
- Do not dispose of batteries in fire.
- Do not charge non-rechargeable batteries.
- Remove rechargeable batteries from the toy before charging (if removable).
- Rechargeable batteries are only to be charged under adult supervision.

## **MISE EN GARDE**

- Utilisez de nouvelles piles alcalines pour une performance maximale.
- Seules des piles du type recommandé doivent être utilisées.
- Ne pas mélanger différents types de piles ou d'accumulateurs, ne pas mélanger des piles ou des accumulateurs neufs avec des usagés.
- Ne pas utiliser des piles ou des accumulateurs endommagés.
- Mettre en place les piles ou les accumulateurs en respectant les polarités + et -.
- Ne pas mettre les bornes d'une pile ou d'un accumulateur en court-circuit (en reliant directement le + et le -).
- Enlever les piles ou les accumulateurs usagés du jouet.
- Retirer les piles ou les accumulateurs en cas de non-utilisation prolongée.
- Ne les jeter ni au feu ni dans la nature.
- Ne pas tenter de recharger des piles non rechargeables.
- Enlever les accumulateurs du jouet pour les recharger.
- Les accumulateurs ne doivent être chargés que sous la surveillance d'un adulte.

# PRODUCT FEATURES

## 1. Off/Mode Selector Switch

Slide the **Off/Mode Selector Switch** from the Off position to Letter Mode, Music Mode or Story Mode.



### Letter Mode

Press the light-up buttons to learn letters and letter sounds with words from the story.



### Music Mode

Turn the pages to hear a melody and press any of the buttons to play along.

### Story Mode

Turn the pages to hear the story read aloud with fun sounds. Press the light-up buttons to hear sentences again or add fun sounds.

## 2. Volume Control Switch

Slide the **Volume Control Switch** to the Low Volume  or High Volume  position to adjust the volume.

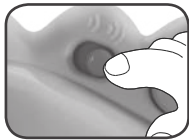

## 3. 16 Colorful Pages

Turn the pages to hear the story read aloud, learn about letters and numbers, or hear music and add fun sounds to play along.



#### 4. 4 Light-Up Buttons

Press the buttons to learn about letters, letter sounds and words from the story.



#### 5. Butterfly Button

Press to hear questions about letters and words from the story.



#### 6. Number Buttons

Press 1-10 to count along and explore numbers.

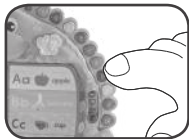

#### 7. Bead Roller

Spin and watch the beads move to practice fine motor skills.



## CARE & MAINTENANCE

1. Keep the unit clean by wiping it with a slightly damp cloth.
2. Keep the unit out of direct sunlight and away from any direct heat sources.
3. Remove the batteries when the unit is not in use for an extended period of time.
4. Do not drop the unit on a hard surface and do not expose the unit to excess moisture.

# TROUBLESHOOTING

If for some reason the program/activity stops working, please follow these steps:

1. Turn the unit **OFF**.
2. Interrupt the power supply by removing the batteries.
3. Let the unit stand for a few minutes, then replace the batteries.
4. Turn the unit back **ON**. The unit will now be ready to play again.
5. If the unit still does not work, replace with an entire set of new batteries.

## Environmental phenomena.

The unit may malfunction if subjected to radio-frequency interference. It should revert to normal operation when the interference stops. If not, it may become necessary to turn the power **OFF** and back **ON**, or remove and reinstall the batteries. In the unlikely event of an electrostatic discharge, the unit may malfunction and lose memory, requiring the user to reset the device by removing and reinstalling the batteries.

## Impact de l'environnement.

Une défaillance de fonctionnement de l'appareil peut survenir s'il est sujet à des interférences avec les fréquences radioélectriques. Le fonctionnement normal de l'appareil devrait reprendre avec l'arrêt des interférences. Si ce n'est pas le cas, il peut s'avérer nécessaire d'éteindre et rallumer l'appareil ou de retirer et réinstaller les piles. Dans l'éventualité peu probable d'une décharge électrostatique, un mauvais fonctionnement et une perte de mémoire de l'appareil peuvent se produire. L'utilisateur doit alors retirer et réinstaller les piles pour réinitialiser l'appareil.



**IMPORTANT NOTE:**

If the problem persists, please call our Consumer Services Department at **1-800-701-5327** in the U.S. or email [support@leapfrog.com](mailto:support@leapfrog.com). Creating and developing LeapFrog® products is accompanied by a responsibility that we take very seriously. We make every effort to ensure the accuracy of the information, which forms the value of our products. However, errors sometimes can occur. It is important for you to know that we stand behind our products and encourage you to contact us with any problems and/or suggestions you might have. A service representative will be happy to help you.

**NOTE:**

This equipment has been tested and found to comply with the limits for a Class B digital device, pursuant to Part 15 of the FCC Rules. These limits are designed to provide reasonable protection against harmful interference in a residential installation. This equipment generates, uses and can radiate radio frequency energy and, if not installed and used in accordance with the instructions, may cause harmful interference to radio communications. However, there is no guarantee that interference will not occur in a particular installation. If this equipment does cause harmful interference to radio or television reception, which can be determined by turning the equipment off and on, the user is encouraged to try to correct the interference by one or more of the following measures:

- Reorient or relocate the receiving antenna.
- Increase the separation between the equipment and receiver.
- Connect the equipment into an outlet on a circuit different from that to which the receiver is connected.
- Consult the dealer or an experienced radio/TV technician for help.

THIS DEVICE COMPLIES WITH PART 15 OF THE FCC RULES. OPERATION IS SUBJECT TO THE FOLLOWING TWO CONDITIONS: (1) THIS DEVICE MAY NOT CAUSE HARMFUL INTERFERENCE, AND (2) THIS DEVICE MUST ACCEPT ANY INTERFERENCE RECEIVED, INCLUDING INTERFERENCE THAT MAY CAUSE UNDESIRE OPERATION.

*CAN ICES-3 (B)/NMB-3(B)*

**Caution:** Changes or modifications not expressly approved by the party responsible for compliance could void the user's authority to operate the equipment.



CLASS 1  
LED PRODUCT

***For warranty information, please visit  
leapfrog.com/warranty.***

LeapFrog Enterprises, Inc.,  
a subsidiary of VTech Holdings Limited.  
TM & © 2017 LeapFrog Enterprises, Inc.  
All rights reserved.



*Visit our website for more  
information about our products,  
downloads, resources and more.*

*[leapfrog.com](http://leapfrog.com)*